



Quad VGA and Ultralow Noise Preamplifier with Programmable R_{IN} Evaluation Board

AD8334-EVAL

FEATURES

- Factory tested
- Provisions for direct measurement
- Optional differential-to-single-ended output
- Provision for LNA output measurement
- Selectable high or low gain
- Provision for input calibration
- Provision for clamping resistors
- Single-supply operation

APPLICATIONS

- Test gain interface circuitry
- Evaluate clamping characteristics
- Evaluate effects of dynamic drive signals
- TGC evaluate system characteristics
- Medical ultrasound systems
- Industrial ultrasound systems
- PC layout guidance
- Evaluate performance with real-world signals

GENERAL DESCRIPTION

The AD8334-EVAL is a platform for the test and evaluation of the AD8334 variable gain amplifier (VGA). The board is shipped assembled and tested, and users only need to connect the signal and VGAIN sources and a single 5 V power supply. Figure 1 is a photograph of the board.

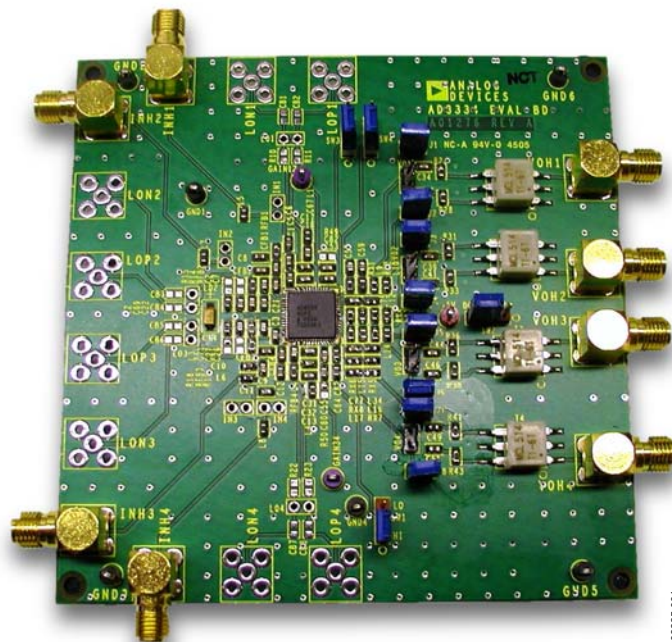

Figure 1.

Rev. 0

Information furnished by Analog Devices is believed to be accurate and reliable. However, no responsibility is assumed by Analog Devices for its use, nor for any infringements of patents or other rights of third parties that may result from its use. Specifications subject to change without notice. No license is granted by implication or otherwise under any patent or patent rights of Analog Devices. Trademarks and registered trademarks are the property of their respective owners.

One Technology Way, P.O. Box 9106, Norwood, MA 02062-9106, U.S.A.
Tel: 781.329.4700 www.analog.com
Fax: 781.461.3113

©2006 Analog Devices, Inc. All rights reserved.

TABLE OF CONTENTS

Features	1	Measurement Setup.....	5
Applications.....	1	Board Layout and Parts List.....	5
General Description	1	Ordering Information.....	8
Revision History	2	Ordering Guide	8
Configuring the Input Impedance	3	ESD Caution.....	8
Schematic.....	4		

REVISION HISTORY

7/06—Revision 0: Initial Version

CONFIGURING THE INPUT IMPEDANCE

The board is built and tested using the components shown in black (see Figure 2). Provisions are made for optional components (shown in gray) that can be installed at the user's discretion. As shipped, the input impedances of the low noise amplifiers (LNAs) are configured for 50 Ω to match the output impedance of most signal generators and network analyzers. Input impedances up to 6 kΩ can be realized by changing the values of the feedback resistors, R_{FB1}, R_{FB2}, R_{FB3}, R_{FB4}, and shunt capacitors, C6, C8, C10, and C12. See the AD8331/AD8332/AD8334 data sheet for additional details on this circuit feature. For reference, Table 1 lists standard values of 1% resistors for some typical values of input impedance. Of course, if the user has determined that the source impedance falls between these values, the feedback resistor value can be calculated accordingly. Note that the board is designed to accept standard surface-mount, size 0603 components.

Table 1. LNA External Component Values for Common Source Impedances

R _{IN} (Ω)	R _{FB1} , R _{FB2} , R _{FB3} , R _{FB4} (Ω, ±1%)	C6, C8, C10, C12 (pF)
50	274	22
75	412	12
100	562	8
200	1.13 k	1.2
500	3.01 k	No capacitor
6 k	No resistor	No capacitor

Driving the VGA from an External Source, or Using the LNA to Drive an External Load

Appropriate components can be installed if the user wishes to drive the VGA directly from an external source or to evaluate the LNA output. If the LNA is used to drive off-board loads or cables, small value series resistors (47 Ω to 100 Ω) are recommended for LNA decoupling. These can be installed in the R10, R11, R14, R15, R18, R19, R22, and R23 spaces.

Provisions are made for surface-mount SMA connectors that can be used for driving from either direction. If the LNA is not used, it is recommended that the capacitors, C16, C17, C21, C22, C26, C27, C31, and C32, be carefully removed to avoid driving the outputs of the LNAs.

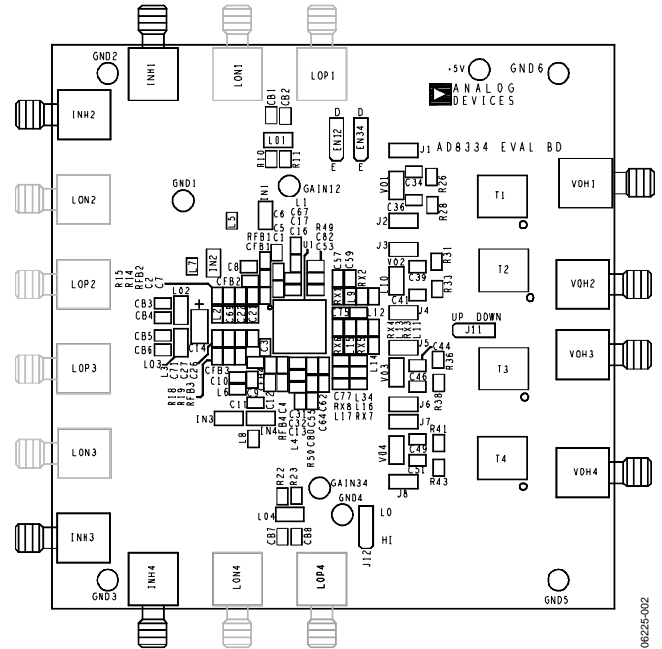

Figure 2. Assembly

Using the Clamp Circuit

The board is shipped with no resistors installed in the spaces provided for clamp-circuit operation. Note that each pair of channels shares a clamp resistor, and the value is selected the same as it is in the AD8331/AD8332/AD8334 data sheet. If the output clamping is desired, the resistors are installed in R49 and R50. The peak-to-peak clamping level is application dependent, and appropriate values are listed in the AD8331/AD8332/AD8334 data sheet.

Viewing Signals

The preferred signal detector is a high impedance differential probe, such as the Tektronix P6247, 1 GHz differential probe, connected to the 2-pin headers (VO1, VO2, VO3, or VO4), as shown in Figure 4. The low capacitance of this probe has the least effect on the performance of the device of any detection method tried. The probe can also be used for monitoring input signals at IN1, IN2, IN3, or IN4. It can also be used for probing other circuit nodes; however, beware that the 200 kΩ input impedance can affect certain circuits.

Differential-to-single-ended transformers are provided for single-ended output connections. Note that series resistors are provided to protect against accidental output overload should a 50 Ω load be connected to the connector. Of course, the effect of these resistors is to limit the bandwidth. If the load connected to the SMA is > 500 Ω, the 237 Ω series resistors, RX1, RX2, RX3, RX4, RX5, RX6, RX7, and RX8, can be replaced with 0 Ω values.

AD8334-EVAL

SCHEMATIC

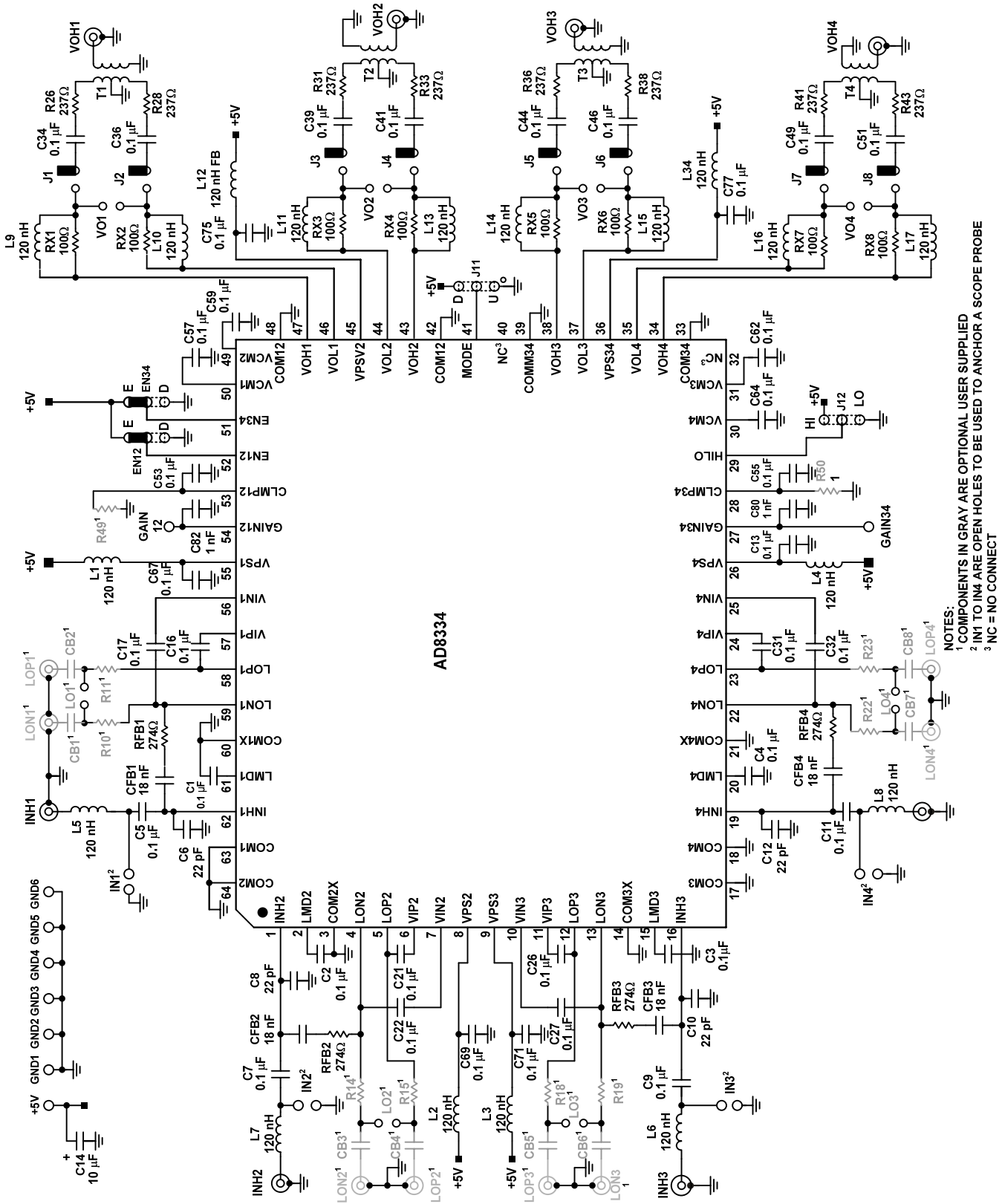

Figure 3. Evaluation Board Schematic

MEASUREMENT SETUP

The basic board connections for measuring bandwidth are shown in Figure 4. A 5 V, 200 mA (minimum) power supply is required, and a low noise voltage reference supply is required for VGAIN.

BOARD LAYOUT AND PARTS LIST

The evaluation board circuitry uses four conductor layers. The two inner layers are ground, and all interconnecting circuitry is located on the outer layers. Figure 5, Figure 6, Figure 7, Figure 8, and Figure 9 illustrate the copper patterns, and Table 2 is a parts list.

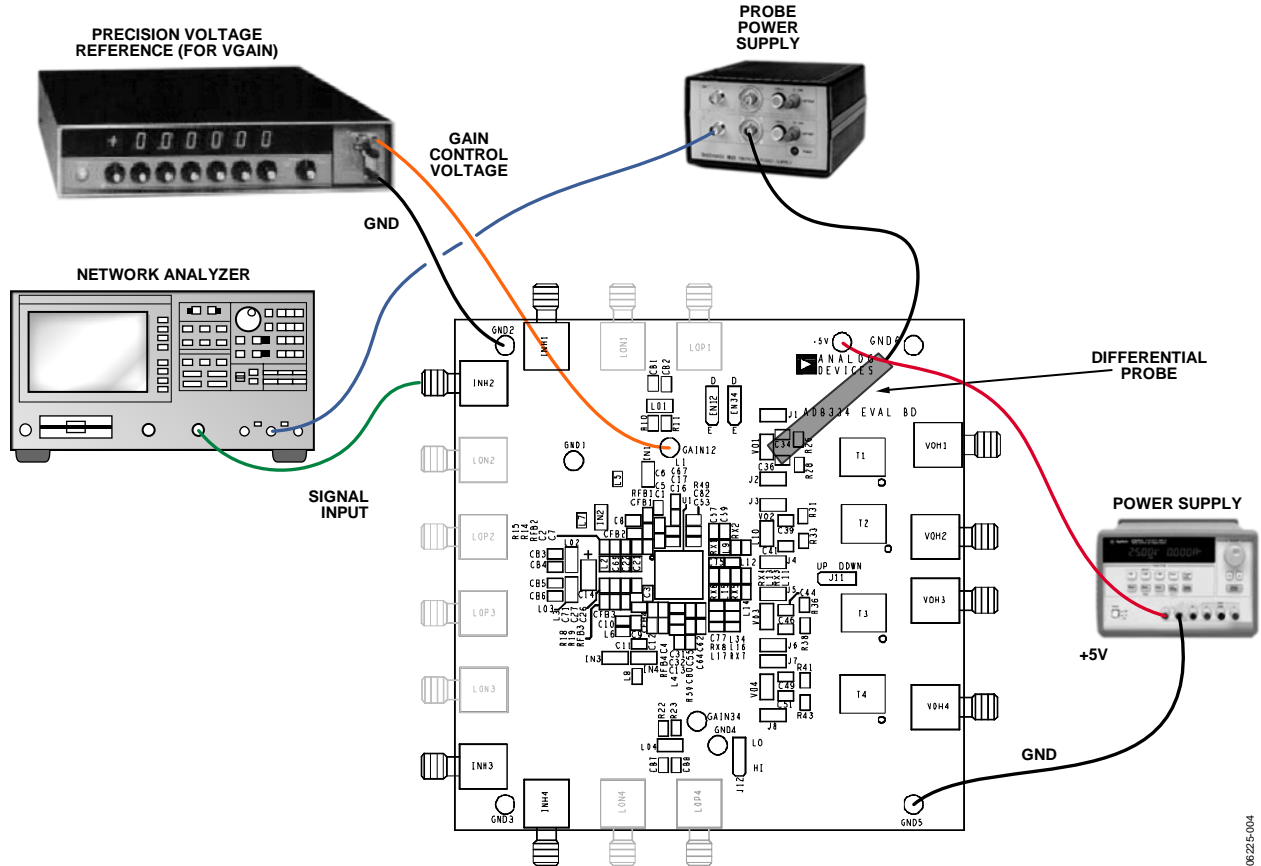

Figure 4. Typical Board Test Connections (One Channel Shown)

08225-004

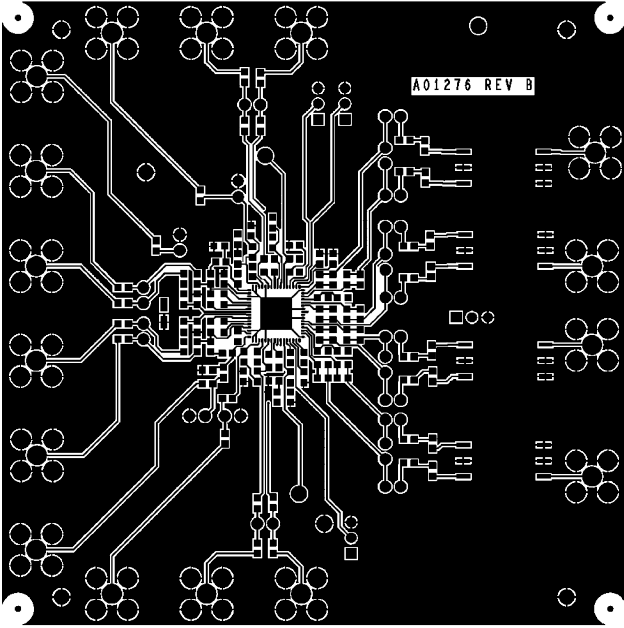

Figure 5. Component Side Copper

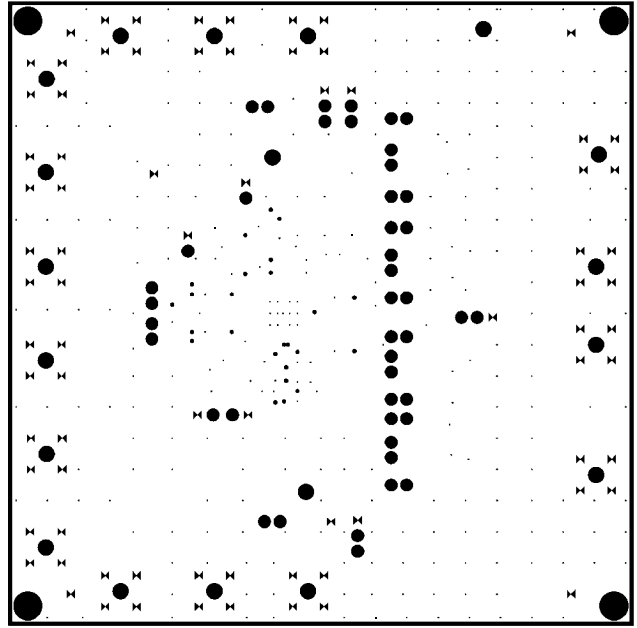

Figure 7. Inner Layer No. 1

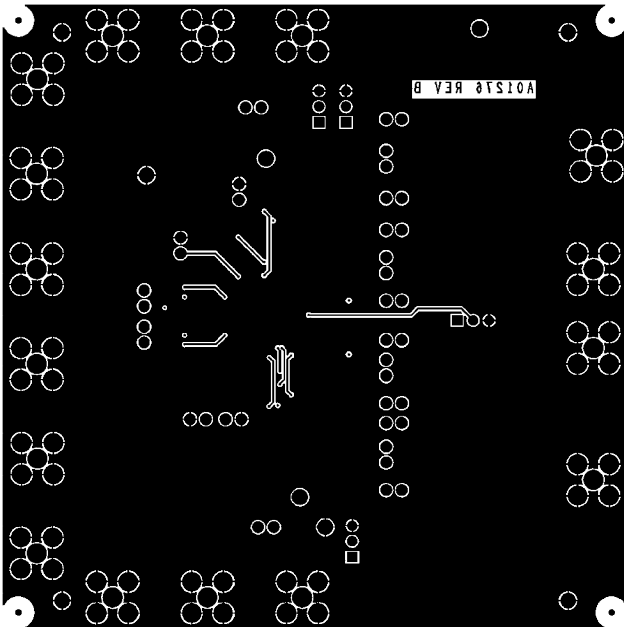

Figure 6. Wiring Side Copper

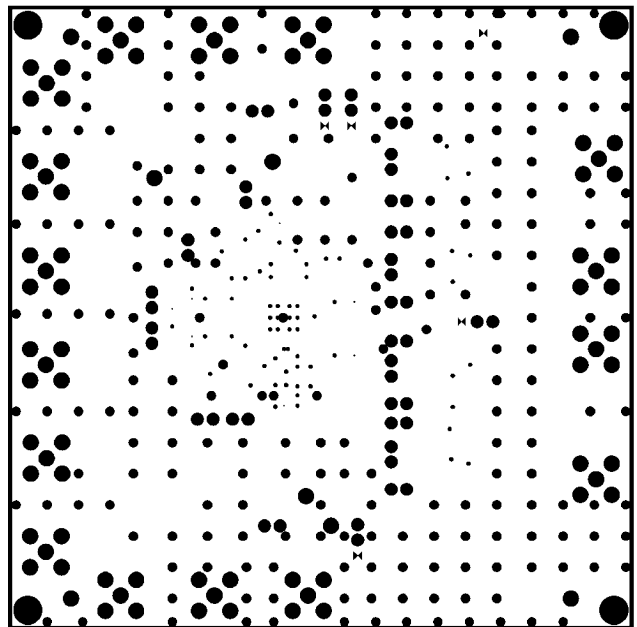

Figure 8. Inner Layer No. 2

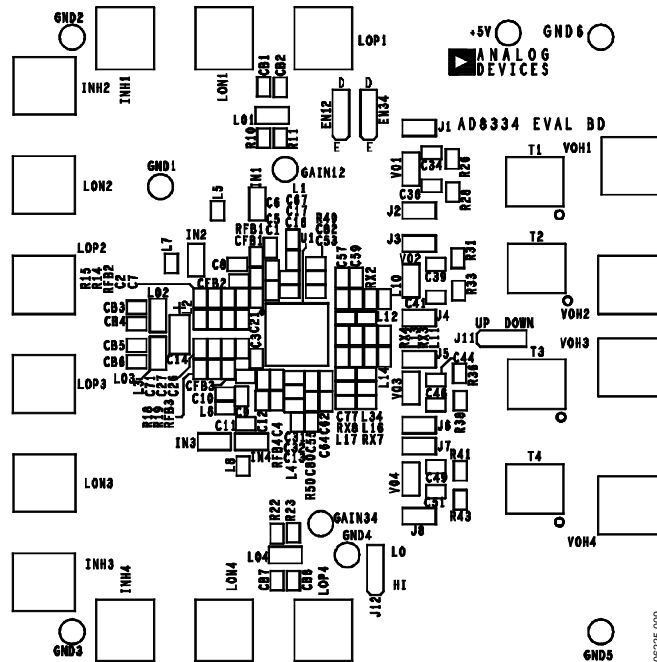

Figure 9. Component Side Silk-Screen

Table 2. Parts List

Qty.	Name	Description	Reference Designator	Manufacturer	Mfg. Part No.
1	Test Loop	0.125" diameter, red	+5V	Bisco, Inc.	TP-104-01-02
6	Test Loops	0.125" diameter, blk	GND1 to GND6	Bisco, Inc.	TP-104-01-00
2	Test Loops	0.125" diameter, purple	GAIN12, GAIN34	Bisco, Inc.	TP-104-01-07
36	Capacitors	0.1 μ F, 16 V, 0603	C1, C2, C3, C4, C5, C7, C9, C11, C13, C16, C17, C21, C22, C26, C27, C31, C32, C34, C36, C39, C41, C44, C46, C49, C51, C53, C55, C57, C59, C62, C64, C67, C69, C71, C75, C77	KEMET Corp.	C0603C104K4RAC
4	Capacitors	22 pF, 5%, 50,V, 0603	C6, C8, C10, C12	Panasonic	ECJ-1VC1H220J
2	Capacitors	1 nF, 10%, 100 V, 0603	C80, C82	Panasonic	ECJ-1VB2A102K
4	Capacitors	18 nF, 0603	CFB1, CFB2, CFB3, CFB4	Panasonic	ECJ-1VB1E183K
12	Headers	0.1" 2-Pin	J1, J2, J3, J4, J5, J6, J7, J8, VO1, VO2, VO3, VO4	FCI	69157-102
8	Connectors	SMA Fem PC MT, RA	INH11 to INH14, VOH11 to VOH4	Amphenol Corp.	901-143-6RFX
18	Ferrite Beads	120 nH, 0603	L1, L2, L3, L4, L5, L6, L7, L8, L9, L10, L11, L12, L13, L14, L15, L16, L17, L34	Murata	BLM18BA750SN1D
8	Resistors	237 Ω , 1%, 1/16W, 0603	R26, R28, R31, R33, R36, R38, R41, R43	Panasonic	ERJ-3EKF2370V
4	Resistors	274 Ω , 1%, 1/10W, 0603	RFB1, RFB2, RFB3, RFB4	Panasonic	ERJ-3EKF2740V
8	Resistors	100 Ω , 1%, 1/16W, 0603	RX1, RX2, RX3, RX4, RX5, RX6, RX7, RX8	Panasonic	ERJ-3EKF1
4	Headers	0.1" 3-pin	EN12, EN34, J11, J12	Molex	22-10-2031
4	Transformers	RF 0.015 MHz to 300 MHz	T1, T2, T3, T4	Mini-Circuits	T1-6T KK81
1	IC	Quad VGA	U1	Analog Devices, Inc.	AD8334ACPZ
4	Foot	Bumper	Mount to Wiring Side of Board	3M	SJ-67A11
12	Mini-Jump Jumpers		Install at J1 to J8; J11: up, J12: high; EN12 (lower position); EN34 (lower position)	FCI	65474-001
1	Capacitor	10 μ F, 10 V, A Size Not inserted	C14 IN1 to IN4, CB1 to CB8, LO1 to LO4, LON1 to LON4, LOP1 to LOP4, R10, R11, R14, R15, R18, R19, R22, R23, R49, R50	Nichicon Corp.	F931A106MAA

AD8334-EVAL

ORDERING INFORMATION

ORDERING GUIDE

Model	Description
AD8334-EVAL	Evaluation Board

ESD CAUTION

ESD (electrostatic discharge) sensitive device. Electrostatic charges as high as 4000 V readily accumulate on the human body and test equipment and can discharge without detection. Although this product features proprietary ESD protection circuitry, permanent damage may occur on devices subjected to high energy electrostatic discharges. Therefore, proper ESD precautions are recommended to avoid performance degradation or loss of functionality.

